

ESPRESSO MAKER WITH CAPSULES

Model: Café Supreme

HEMC-DD15BK



- Digital panel and Touch control
 - Water tank capacity: 1.5 L
- Compatible with Nespresso, Dolce Gusto and coffee powder/ESE pods

HEINNER

1. INTRODUCTION

Please read the instructions carefully and keep the manual for future information.

This manual is designed to give all necessary instructions concerning installation, use and maintenance of the unit. In order to operate the unit correctly and safely, please read this instruction manual carefully before installation and use.

2. CONTENT OF YOUR PACKAGE

- ➔ Espresso maker with capsules
- ➔ User manual
- ➔ Certificate of warranty
- ➔ Declaration of conformity

3. SAFETY MEASURES

GENERAL

1. Read all instructions before using.

2. Check that the voltage you are using matches the rated voltage of the product.
3. If the supply cord is damaged, it must be replaced by the manufacturer, its service agent or similarly qualified persons in order to avoid a hazard.
4. This appliance can be used by children aged from 8 years and above and persons with reduced physical, sensory or mental capabilities or lack of experience and knowledge if they have been given supervision or instruction concerning the use of the appliance in a safe way and understand the hazards involved. Children shall not play with the appliance. Cleaning and user maintenance shall not be made by children unless they are older than 8 and supervised.
5. Keep the appliance and its cord out of reach of children less than 8 years.
6. To disconnect, turn any control to "OFF" and remove the plug from the wall outlet. Always hold the plug but never pull it out by hanging it.
7. Unplug it from the outlet when it is not in use and before cleaning. Allow the appliance to cool down before putting on or taking off parts, and before cleaning it.
8. The use of accessories not recommended by the appliance manufacturer may result in fire, electric shock or injury to people.
9. Do not use it outdoors.
10. Do not use appliances for other activities than the intended use.
11. Do not let the cord hang over edge of table or counter or touch any hot surfaces.
12. Do not place the appliance on or near a hot gas, an electric burner, or in a heated oven.
13. Do not let the coffee machine operate without water.
14. To protect against fire, electric shock and injury to persons, do not immerse the cord and plug in water or any other liquid.
15. The container is designed for use with this appliance. It must never be used on a range top.
16. Do not clean the container with cleansers, steel wool pads, or other abrasive material.
17. Be careful not to get burned by the steam during the brewing cycles.
18. Some parts of appliance are hot when operated, so do not touch it with hand. Use handles or knobs only.
19. The appliance must not be immersed in any kind of liquid.

20. This appliance is intended to be used for household use only.
21. The heating element surface is a subject to residual heat after use.
22. Switch off the appliance and disconnect it from the supply before changing accessories or approaching parts that move during use.
23. Keep this manual for future reference.



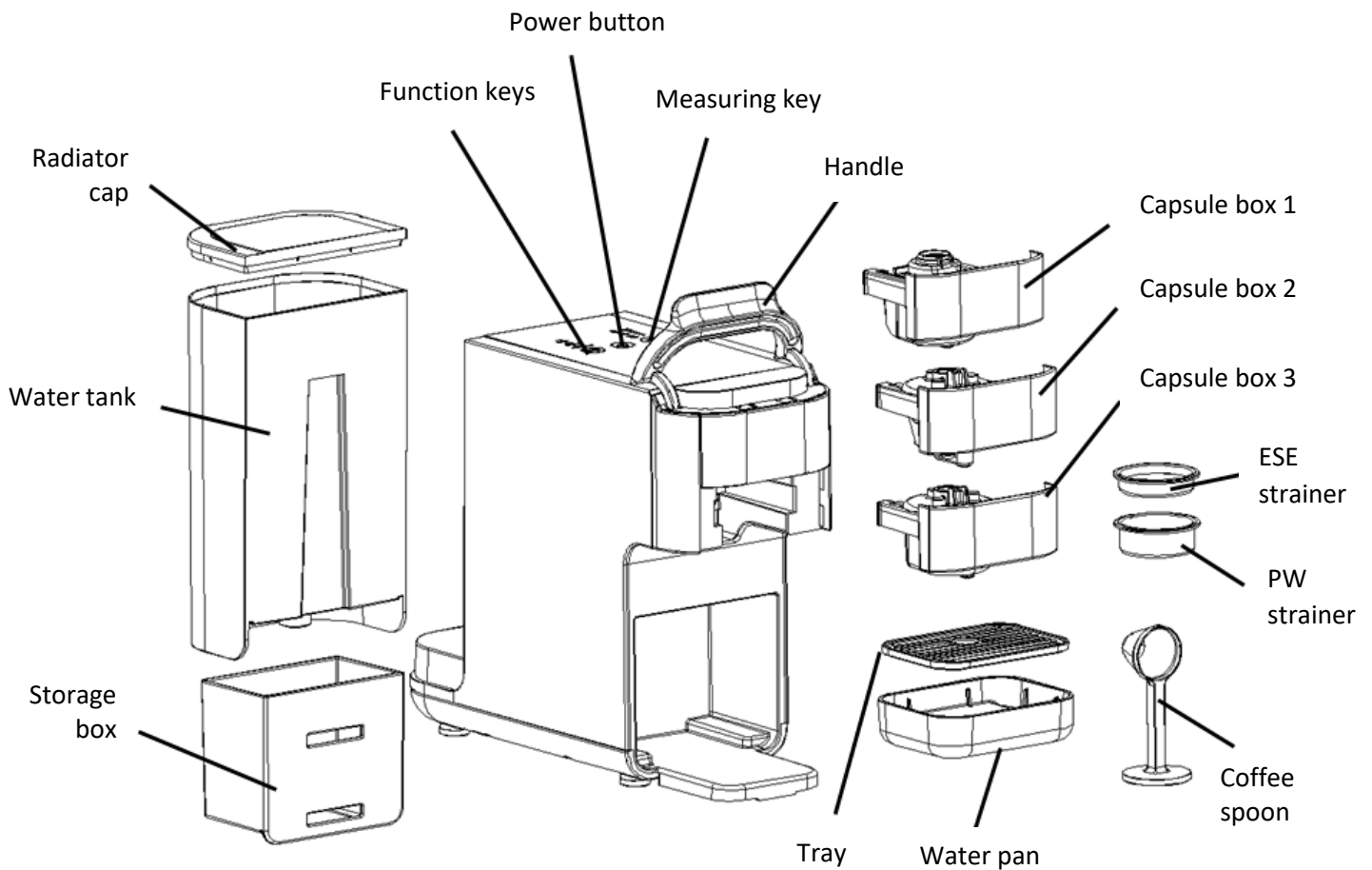

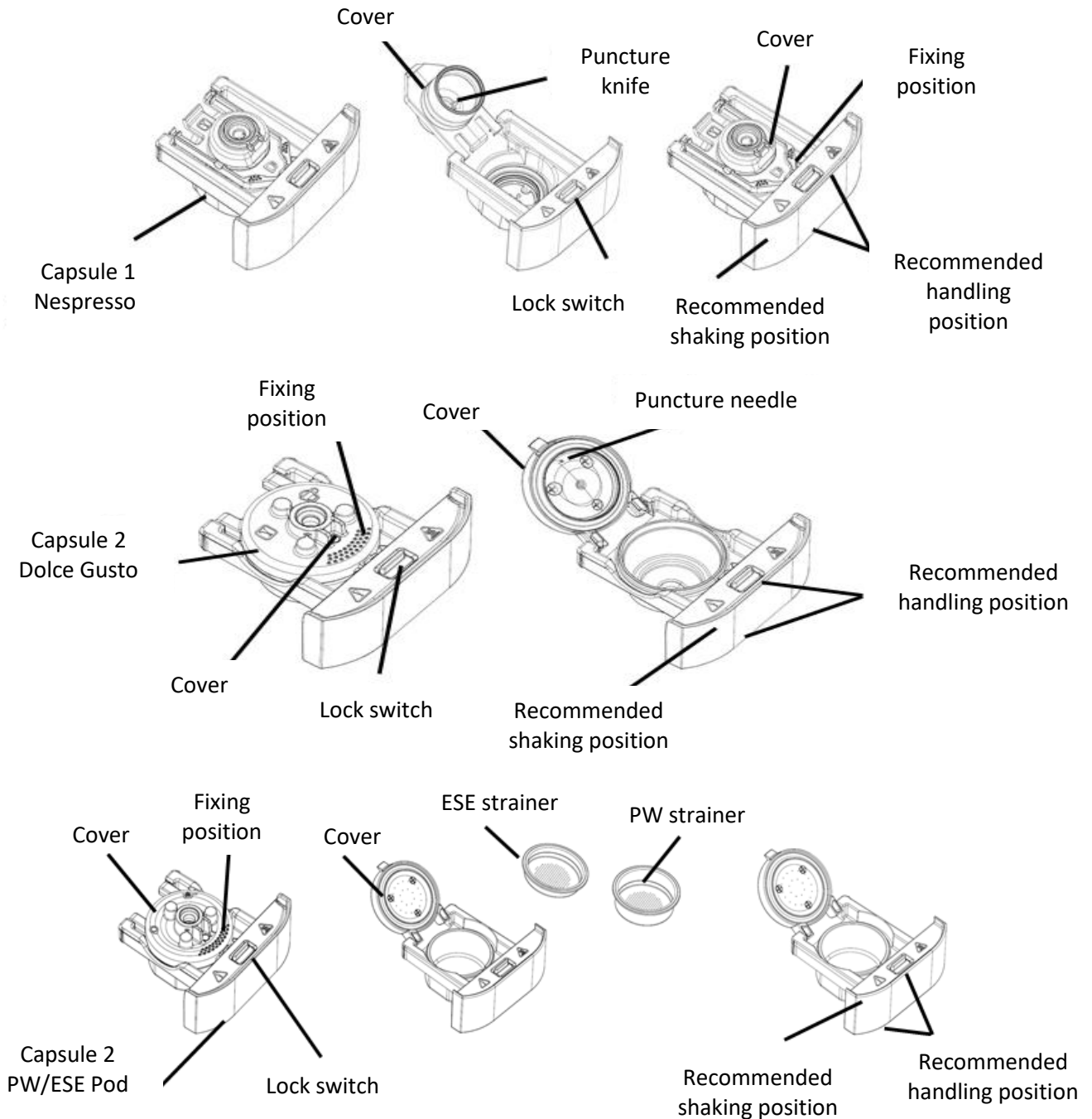



4. PRODUCT DESCRIPTION









5. USING THE APPLIANCE

GENERAL

Check and make sure all accessories are in good order. Fill the water tank, open the handle, insert the capsule box into the host, press down the handle and make sure the handle is closed. Place a container on the coaster, plug it in, and press the power/start/stop button to warm up. Power/unlock key  - its light starts to flicker until ,  or  indicators lights are on. This will indicate that the appliance is preheated. With the appliance, you can select the function you want: ,  or . Press the cup key to select , ,

 or  gears, followed by the Power/Start/Stop button . After a while, the water begins to flow out of the coffee nozzle, and after receiving a certain amount of water, the machine will stop flowing out.

Attention: Power/Start/Stop button  - the machine makes the sound of pumping water. This means that the machine is pumping water to make coffee, which is normal in this case.

Note: When the handle is opened, each indicator on the panel blinks, and each function key cannot be operated at this time.

Warning: This appliance is only suitable for Nespresso capsules, Dolce Gusto capsules, ESE bags, coffee powder capsules.

Warning: Do not open the handle during the brewing process, otherwise there will be an anomaly or water leakage.

OPERATION

Making coffee:





1. When the preheat is complete, press the function key in the next sequence to activate the desired function:

- **once** for the Nespresso 



- **twice** for Dolce Gusto 

- **three times** for Powder/ESE 

2. Press the cup button again and select between the available quantities of coffee which can be prepared

with the chosen function: single , Double  or Lungo . After that, press the power/Start/Stop button , enabling the corresponding function coffee to begin.

Note: for Dolce Gusto capsules choice - the cup indicator light will automatically switch to the 1-7 grid lamp area. After that, press the cup key and you will have to choose from low to high 1 grid, 2 grid, 3 grid, 4 grid,



5 grid, 6 grid, 7 grid light on the  Incremental lighting symbol (For example, the lights are on in 3 levels and 3 bars as standard). When selected, press the power/Start/Stop button  and the appliance will automatically start the corresponding function coffee.



Cup selection:

Function/cup size	Single	Double	Lungo
Nespresso	30 ml	60 ml	110 ml
Powder/ESE Pod	30 ml	60 ml	110 ml

Function/cup size	1	2	3	4	5	6	7
Dolce Gusto	30ml	40ml	70ml	110ml	160ml	170ml	220ml

Flow regulating function:

When there is chosen one of Nespresso, powder/ESE/SES Pod functions, and in the standby mode, as long as the corresponding flow gear light is on (Single , Double , Lungo ) , then you can start to set.

For example, when Single cup key  lights on, press the cup key  for 2 seconds making the coffee appliance to work, and the cup key  will flash. Wait for the desired amount of coffee flowing out, then press the cup key again. The coffee stops dispensing, the appliance will automatically save the setting you made, and it will enter in standby mode.

Attention:

1. The flow regulating function would not disappear even though the appliance is restarted after shutting down.
2. If the setting flow exceed the adjustable range, it will automatically record the maximum.
3. If the setting flow is less than the adjustable range, it will automatically record the minimum.
4. The Flow setting only applies to Nespresso, Powder/ESE Pod functions; Dolce Gusto function cannot customize flow regulation.



Flow alarm reminder:

In the process of making coffee, when the function key  and the cup key  flash at the same time, the pump stops working:



1. The nozzle does not work; check if there is not enough water and if discovered like so, add it in the tank (you may need to wait 2 minutes to be able to restart the making of coffee).
2. coffee flows out too slow; the capsule box may be blocked- check the capsule box and clean it;
3. coffee flows out too slow; check the using capsule brand is correct or not because other brands capsules might not match the size resulting the function to operate abnormally.



Descaling reminder:

When the appliance runs for more than 500 cycles, the machine will automatically show the descaling warning. The descaling reminder will only clear out after using the descaling function. Under the descaling alarm state, the coffee can be brewed normally (the current number of cycles will not be cleared after restoring the factory settings).



Descaling alarm display: function  and cup key  indicators flashing alternately.

Descaling method:

When the appliance enters in standby mode, press the function  and the cup  key for 5 seconds to enter the descaling function mode.

At this time, the indicator light of the function  and the cup  key will flash rapidly at the same time. After adding an appropriate amount of descaling agent to the water tank, press the power button (start/stop button) , and the coffee machine will start this process (a duration of approximately 2 minutes).





Exit descaling function:

When you access the descaling program, press the function  and the cup  key for 5 seconds at the same time. The appliance will automatically exit the descaling program and will enter into the normal working state; or just shut down the appliance and re-start it to exit the descaling function.

15-min Sleeping mode:

In a normal state of operation, after it is turned on and preheated, the appliance enters into standby mode, and, by not choosing any function for 15 minutes, the appliance will enter into sleep mode. Or in the flow alarm mode and not choosing any key for 4 minutes, the appliance will enter into the same sleep mode. After pressing any key or turning the handle, the machine will wake up and restart the pre-heating process.

Factory data reset:

When it is plugged but in Standby mode, press the function  and cup  key for 5 seconds at the same time, which will be followed by a long sound. Applying this method, the function  and cup  key will blink quickly for 3 seconds simultaneously, indicating that the factory Settings have been restored, the flow rate of each function is restored to the default value, and the coffee appliance will return to the normal standby state.

Attention:

1. Coffee can only be made after preheating.
2. If there is no operation within 15 minutes after the coffee button indicator is on, the machine will enter standby mode, and the three indicators will be shut down.
3. During brewing, the process can be cancelled by pressing the power/start/stop key. If you want to restart the brewing process, simply press the Power/Start/Stop button again.
4. Press the function key and the cup key according to your own needs, and then its corresponding indicator will light up.
5. Press the power/Start/stop button and, after a while, the coffee will flow out of the coffee mouth. Once the desired amount of coffee is obtained, the coffee will automatically stop flowing and the corresponding indicator light will be on.
6. After brewing, open the handle, take out the capsule box, pull the buckle, open the capsule lid, and clean the capsule.

Warning:

- Do not open the handle during the brewing cycle.
- Do not open the handle immediately after brewing; wait 5 seconds before opening the handle.
- If you want to brew another cup of coffee, then continue with a new capsule.
- Empty the capsule box and flush the capsule box and tank frequently when the appliance is not in use.

6. CLEANING AND MAINTENANCE

Before cleaning, unplug the appliance and cool it thoroughly. Do not immerse this product, its power cord or plug in water or other liquids to avoid fire, leakage or personal safety. After each use, make sure to unplug first. Clean regularly as follows:

1. Clean the detachable water tank with a dry cloth.
2. Empty and clean the capsule box.
3. Clean the capsule infuser with a dry cloth.
4. Wipe the coaster clean with a damp cloth.
5. Use a damp cloth to clean the machine.
6. Install all components for the next use.

Note: Before cleaning, first boil water, clean the pipeline in the appliance, and then power it off for cooling.

7. TROUBLESHOOTING

Malfunction	Solution
The control panel is not light up.	Check that the plug is in place and that the button is pressed.
The machine is making strange noises.	Check the water tank.
The indicator lights up, but no coffee comes out.	The wrong capsule may have been used. Wait a few seconds and try again with the new capsule.
There's a water mark on the bottom of the appliance.	Make sure the water tank is properly installed.
The capsule box cannot be placed inside the appliance.	Check that the handle is open properly, the handle needs to be opened before the capsule can be placed in the dedicated box.
You'll hear a hissing sound when the coffee comes out.	This is not a fault, but a normal pressure control valve.

CUSTOMER CARE AND SERVICE

Always use original spare parts.

When contacting our Authorised Service Centre, ensure that you have the following data available: Model and Serial Number.

The information can be found on the rating plate. Subject to change without notice.

TECHNICAL DATA

Water tank capacity	1.5 L
Power	1215-1545 W

Thank you for purchasing this product. If you need support with your product, visit our website using the links below.

Get User manuals: <https://www.heinner.ro>

Get Service information: <https://www.heinner.ro>



Environment friendly disposal

You can help protect the environment!

Please remember to respect the local regulations: hand in the non-working electrical equipment's to an appropriate waste disposal center.



HEINNER is a registered trademark of **Network One Distribution SRL**. Other brands and product names are trademarks or registered trademarks of their respective holders.

No part of the specifications may be reproduced in any form or by any means or used to make any derivative such as translation, transformation, or adaptation without permission from NETWORK ONE DISTRIBUTION.

Copyright © 2013 Network One Distribution. All rights reserved.

www.heinner.com, <http://www.nod.ro>



This product is in conformity with norms and standards of European Community.



Producer & importer: **Network One Distribution**

Marcel Iancu Street, 3-5, Bucharest, Romania

Tel: +40 21 211 18 56, www.heinner.com, www.nod.ro

office@nod.ro

ESPRESSOR CU CAPSULE

Model: Café Supreme

HEMC-DD15BK



- Panoul digital și control tactil
- Capacitatea rezervorului de apă: 1,5 L
- Compatibil cu capsulele Nespresso, Dolce Gusto și monodoze cu cafea măcinată/ESE

HEINNER

1. INTRODUCERE

Vă rugăm să citiți instrucțiunile cu atenție și să păstrați manualul pentru consultări ulterioare. Acest manual are scopul de a vă oferi toate instrucțiunile necesare cu privire la instalarea, utilizarea și întreținerea aparatului. Pentru utilizarea corectă și în siguranță a aparatului, vă rugăm să citiți cu atenție acest manual de instrucțiuni înainte de instalare și utilizare.

2. CONȚINUTUL PACHETULUI DUMNEAVOASTRĂ

- ➔ **Espressor cu capsule**
- ➔ **Manual de utilizare**
- ➔ **Certificat de garanție**
- ➔ **Declarație de conformitate**

3. MĂSURI DE SIGURANȚĂ

GENERALITĂȚI

1. Citiți toate instrucțiunile înainte de utilizare.

2. Verificați tensiunea disponibilă în locul de utilizare, pentru a vă asigura că aceasta corespunde specificațiilor aparatului.
3. Pentru evitarea pericolelor, în cazul în care cablul de alimentare este deteriorat, acesta trebuie înlocuit de către producător, de către agentul său de service sau de persoane cu o calificare similară.
4. Aparatul poate fi utilizat de către copii cu vârste începând de la 8 ani și de către persoane cu capacități fizice, senzoriale sau mentale reduse, cu lipsă de experiență sau cunoștințe, numai dacă acestea sunt supravegheate sau instruite în ceea ce privește utilizarea în siguranță a aparatului și dacă înțeleg pericolele pe care le implică utilizarea. Copiii nu au voie să se joace cu aparatul. Curățarea și întreținerea nu pot fi efectuate de către copii, cu excepția cazului în care aceștia sunt în vârstă de cel puțin 8 ani și sunt supravegheați.
5. Nu lăsați aparatul și cablul de alimentare la îndemâna copiilor cu vârste mai mici de 8 ani.
6. Pentru deconectarea de la sursa de alimentare, rotiți butoanele de comandă la poziția „OPRIT” și scoateți ștecărul din priză. Nu trageți de cablul de alimentare pentru a scoate ștecărul din priză.
7. Deconectați aparatul de la sursa de alimentare atunci când acesta nu este în uz și înainte de efectuarea operațiilor de curățare. Lăsați aparatul să se răcească înainte de atașarea sau detașarea accesoriilor, precum și înainte de curățarea aparatului.
8. Utilizarea de accesorii nerecomandate de către producător poate avea ca rezultat provocarea unui incendiu, electrocutarea sau rănirea persoanelor.
9. Nu utilizați aparatul în aer liber.
10. Nu utilizați aparatul în alt scop decât cel pentru care a fost proiectat.
11. Nu lăsați cablul electric să atârne peste marginea mesei sau a blatului de bucătărie, nici să intre în contact cu suprafețe fierbinți.
12. Nu puneți aparatul pe sau lângă un arzător cu gaz sau electric; nu puneți aparatul într-un cuptor încălzit.
13. Nu lăsați aparatul să funcționeze fără apă.
14. Pentru protejarea împotriva incendiilor, electrocutării și rănirii, nu introduceți cablul de alimentare, ștecărul sau aparatul în apă sau în alte lichide.
15. Vasul este destinat utilizării cu acest aparat. Aceasta nu poate fi utilizată pe mașina de gătit.
16. Nu curățați vasul cu prafuri de curățat, bureți metalici sau alte materiale abrazive.
17. Aveți grijă să nu vă opăriți cu aburii fierbinți în timpul ciclurilor de preparare.
18. În timpul funcționării aparatului, anumite piese ale acestuia sunt fierbinți; nu le atingeți cu mâna. Folosiți numai mânerele sau butoanele.
19. Nu introduceți aparatul în niciun fel de lichid.
20. Acest aparat este destinat numai uzului casnic.
21. După utilizare, suprafața elementului de încălzire rămâne fierbinte.
22. Opriti aparatul și deconectați-l de la sursa de alimentare cu energie electrică înainte de a schimba accesoriul sau de a vă apropia de piesele care se mișcă în timpul funcționării.
23. Păstrați acest manual pentru consultări ulterioare.



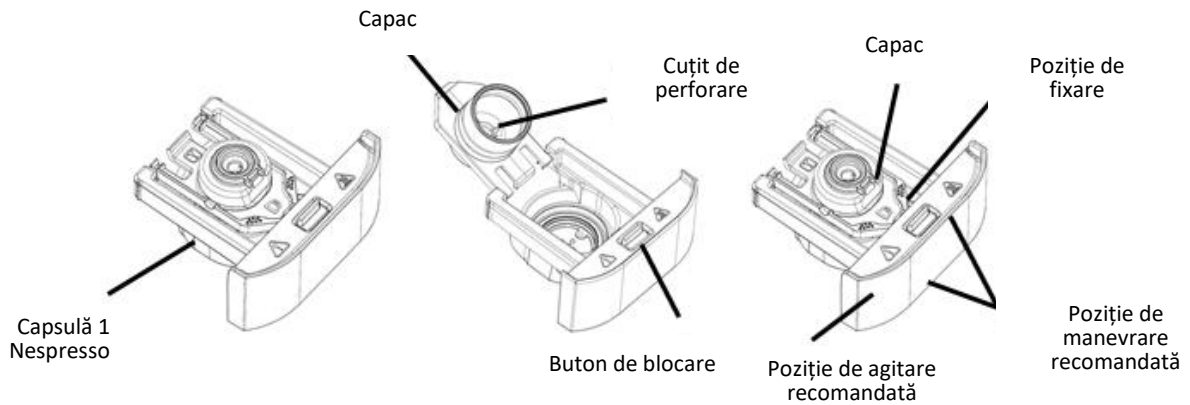
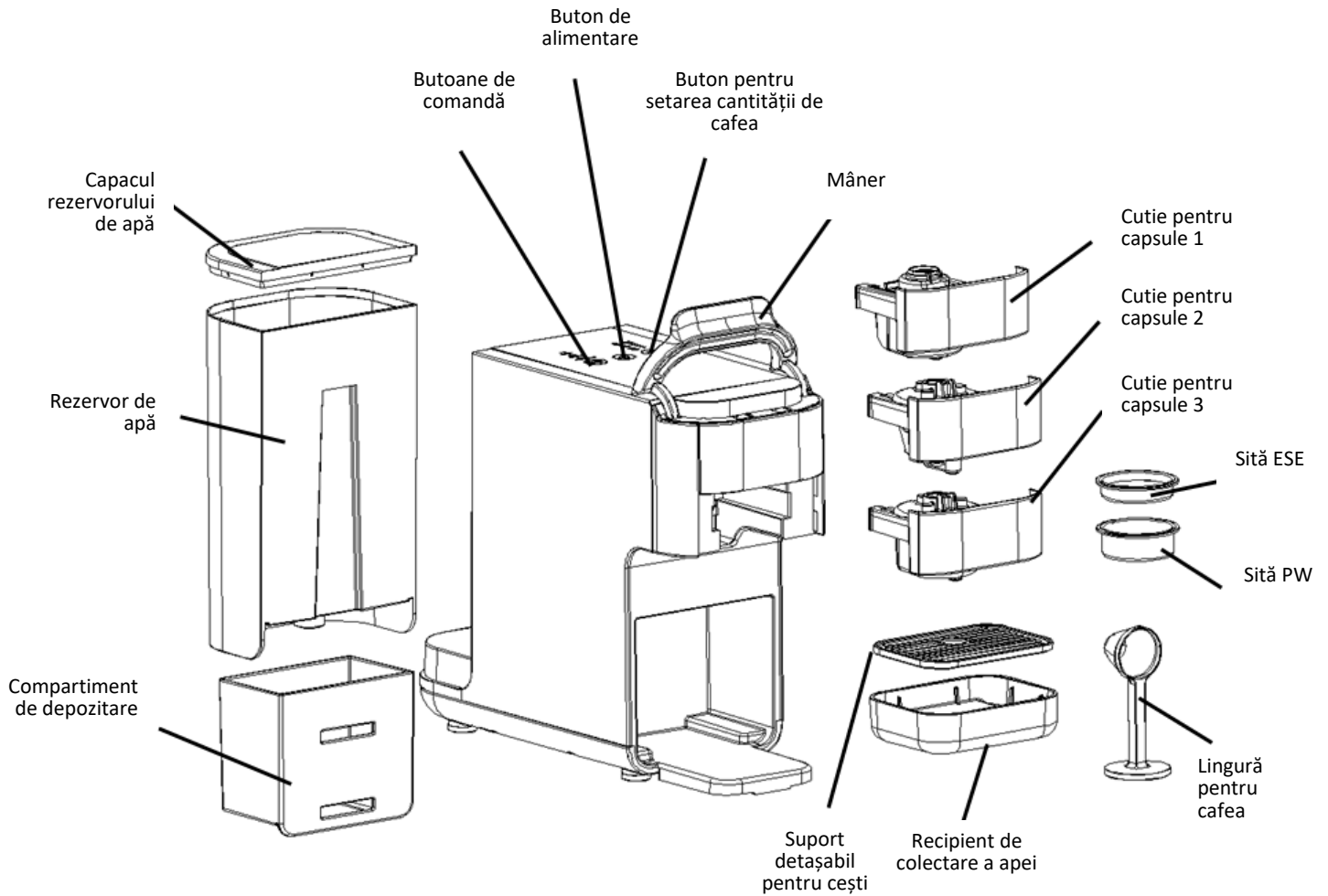

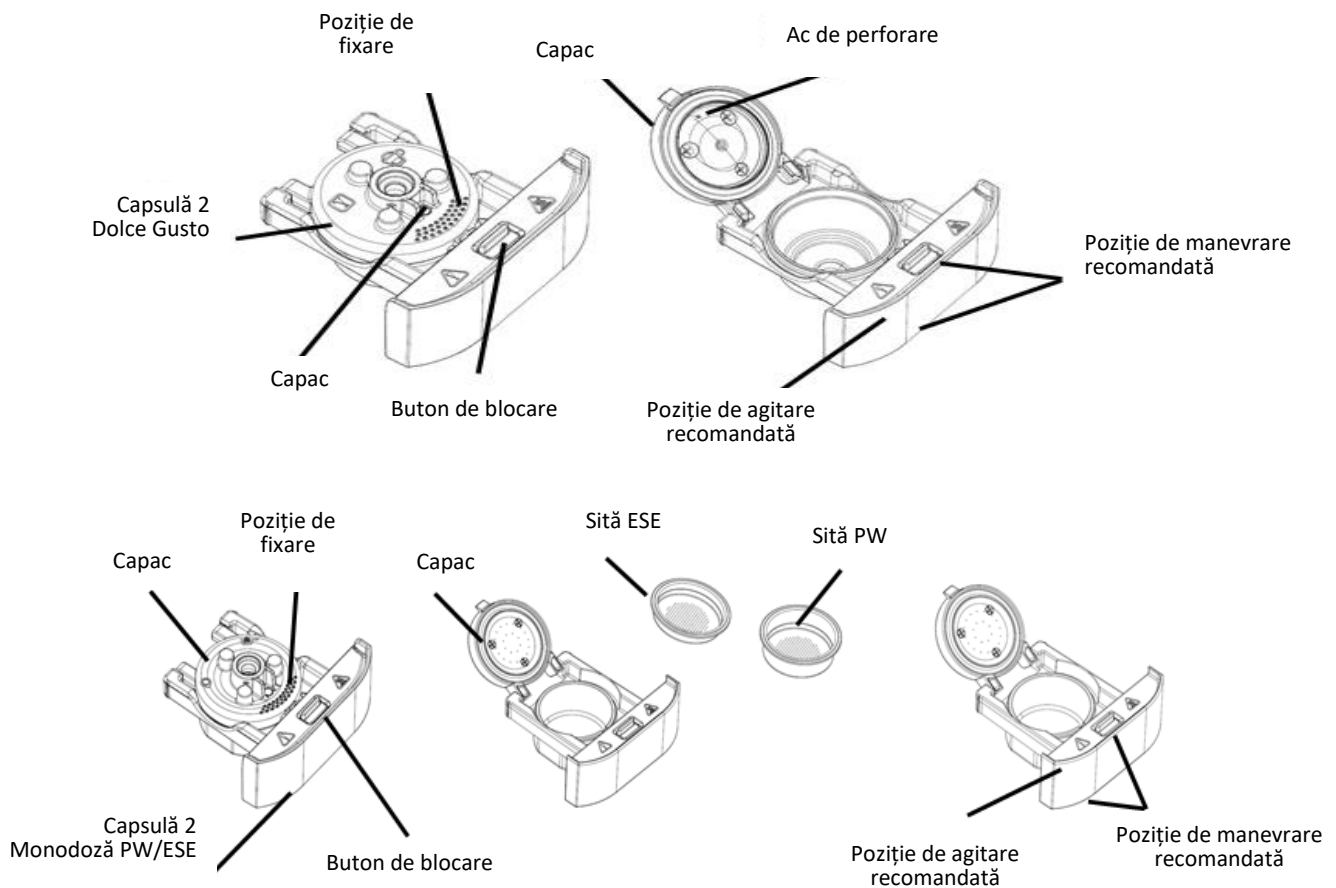







4. DESCRIEREA PRODUSULUI





5. UTILIZAREA APARATULUI

GENERALITĂȚI

Verificați accesoriile pentru a vă asigura că acestea sunt în stare bună. Umpleți rezervorul de apă, deschideți mânerul, introduceți cutia pentru capsule în aparat, apăsați în jos mânerul și asigurați-vă că acesta este închis. Așezați un recipient pe suport, conectați aparatul la sursa de alimentare și apăsați pe butonul de alimentare/start/stop pentru ca aparatul să înceapă să se încălzească. Butonul de alimentare/deblocare  indicatorul aferent acestui buton începe să clipească până când indicatorul ,  sau  se aprinde. Acest lucru va indica faptul că aparatul a finalizat procesul de preîncălzire. Puteți selecta una dintre funcțiile dorite: ,  sau . Apăsați pe butonul de selectare a cantității de cafea pentru a selecta , ,  sau , apoi apăsați pe butonul de alimentare/start/stop . După un scurt timp, apa va începe să curgă din duza de cafea. După curgerea unei anumite cantități de apă, aparatul va opri automat curgerea.

Atenționare: La apăsarea butonului de alimentare/start/stop , aparatul produce un sunet care indică pomparea apei. Aceasta înseamnă că aparatul pompează apă pentru a prepara cafea, ceea ce este normal în acest caz.

Notă: Când mânerul este deschis, fiecare indicator de pe panou clipește, iar butoanele de comandă nu pot fi acționate în acest moment.



Avertisment: Acest aparat este potrivit numai pentru capsule Nespresso, capsule Dolce Gusto, monodoze ESE, capsule cu cafea măcinată.

Avertisment: Nu deschideți mânerul în timpul procesului de preparare a cafelei, pentru a nu afecta curgerea apei.





MOD DE UTILIZARE

Prepararea cafelei:



1. După finalizarea procesului de preîncălzire, apăsați pe butonul de comandă pentru a activa funcția dorită după cum urmează:

- **o dată** pentru Nespresso 
- **de două ori** pentru Dolce Gusto 
- **de trei ori** pentru cafea măcinată/ESE 

2. Apăsați din nou pe butonul de selectare a cantității de cafea și selectați una dintre cantitățile disponibile

de cafea care pot fi preparate: simplă , dublă  sau lungo . După aceea, apăsați pe butonul de alimentare/start/stop , pentru ca prepararea cafelei să înceapă.

Notă: în cazul utilizării capsulelor Dolce Gusto, indicatorul luminos aferent ceștii va comuta automat la zona cu niveluri de la 1 la 7. După aceea, apăsați pe butonul de selectare a cantității de cafea și va trebui să alegeți



între nivelurile de la 1 la 7, reprezentate de zona cu niveluri . Nivelul 1 este cel mai scăzut, iar nivelul 7 este cel mai ridicat. Nivelul 3 este cel standard. După selectare, apăsați pe butonul de alimentare/start/stop , iar și aparatul va porni automat funcția corespunzătoare de preparare a cafelei.



Selectarea ceștii:

Funcție/dimensiune ceașcă	Simplă	Dublă	Lungo
Nespresso	30 ml	60 ml	110 ml
Monodoză cafea măcinată/ESE	30 ml	60 ml	110 ml

Funcție/dimensiune ceașcă	1	2	3	4	5	6	7
Dolce Gusto	30 ml	40 ml	70 ml	110 ml	160 ml	170 ml	220 ml

Funcția de reglare a debitului:

Atunci când este selectată una dintre funcțiile Nespresso, capsulă cafea măcinată/ESE/SES și aparatul este în modul standby, puteți începe setarea atât timp cât este aprins indicatorul luminos corespunzător debitului dorit (simplă , dublă , lungo ).

De exemplu, când indicatorul pentru ceașca de cafea simplă  este aprins, apăsați și mențineți apăsat butonul de selectare a cantității de cafea  timp de 2 secunde pentru a porni aparatul de cafea, iar indicatorul luminos aferent butonului de selectare a cantității de cafea  va începe să clipească. Așteptați până când curge cantitatea de cafea dorită, apoi apăsați din nou pe butonul de selectare a cantității de cafea. Curgerea cafelei se va opri, iar aparatul va salva automat setarea făcută și va intra în standby.

Atenționare:

1. Funcția de reglare a debitului va fi dezactivată chiar dacă aparatul este repornit după oprire.
2. Dacă debitul setat depășește intervalul reglabil, aparatul va înregistra automat valoarea maximă.
3. Dacă debitul setat este sub intervalul reglabil, aparatul va înregistra automat valoarea minimă.

4. Setarea debitului este posibilă doar pentru funcțiile Nespresso și cafea măcinată/capsule ESE; funcția Dolce Gusto nu permite personalizarea reglării debitului.



Memento avertizare debit:

În timpul preparării cafelei, când butonul de comandă  și butonul de selectare a cantității de cafea  clipește simultan, pompa nu mai funcționează:



1. Dacă duza nu funcționează, verificați dacă este suficientă apă în rezervor. Dacă nu este, adăugați apă în rezervor (este posibil să fie nevoie să așteptați 2 minute înainte de a putea relua prepararea cafelei).
2. În cazul în care cafeaua curge prea încet, cutia pentru capsule poate fi blocată - verificați cutia pentru capsule și curățați-o.
3. În cazul în care cafeaua curge prea încet, verificați dacă utilizați marca de capsule corectă. Capsulele altor mărci pot să nu corespundă ca dimensiune, ceea ce poate duce la funcționarea anormală a aparatului.



Memento pentru îndepărtarea depunerilor de calcar:

După efectuarea a peste 500 de cicluri de preparare a cafelei, aparatul va afișa automat avertismentul referitor la necesitatea îndepărtării depunerilor de calcar. Avertismentul va dispărea numai după utilizarea funcției de îndepărtare a depunerilor de calcar. În timp ce funcția de avertizare este activă, aparatul poate funcționa normal (numărul curent de cicluri nu va fi resetat după restabilirea setărilor din fabrică).



Când funcția de avertizare este activă, indicatorul aferent butonului  și cel aferent butonului de selectare a cantității de cafea  clipește alternativ.

Procedura de îndepărtare a depunerilor de calcar:

Când aparatul intră în standby, apăsați și mențineți apăsat timp de 5 secunde butonul  și butonul de selectare a cantității de cafea  pentru a activa funcția de îndepărtare a depunerilor de calcar.

În acest moment, indicatorul luminos aferent butonului  și cel aferent butonului  vor clipi rapid în același timp. După adăugarea unei cantități adecvate de substanță pentru îndepărtarea depunerilor de calcar în rezervorul de apă, apăsați pe butonul de alimentare (butonul start/stop) , iar aparatul va începe procesul (durata este de aproximativ 2 minute).

Dezactivarea funcției de îndepărtare a depunerilor de calcar:

Când funcția de îndepărtare a depunerilor de calcar este activă, apăsați și mențineți apăsat simultan timp de 5 secunde butonul  și butonul de selectare a cantității de cafea . Aparatul va dezactiva automat funcția de îndepărtare a depunerilor de calcar și va reveni la starea normală de funcționare; sau pur și simplu opriți aparatul și reporniți-l pentru a dezactiva funcția de îndepărtare a depunerilor de calcar.





Activarea stării de repaus după 15 minute:

În condiții normale de funcționare, după pornire și preîncălzire, aparatul intră în standby. Dacă nu se selectează nicio funcție timp de 15 minute, aparatul va activa starea de repaus.

De asemenea, dacă funcția de avertizare privind debitul este activă și nu apăsați niciun buton timp de 4 minute, aparatul activează starea de repaus.

După apăsarea oricărui buton sau deschiderea mânerului, aparatul va ieși din starea de repaus și va reporni procesul de preîncălzire.

Revenire la setările din fabrică:

Când aparatul este conectat la sursa de alimentare cu energie electrică, dar în standby, apăsați și mențineți apăsat simultan butonul  și butonul de selectare a cantității de cafea  timp de 5 secunde, iar aparatul va emite un semnal sonor lung. După efectuarea acestei proceduri, indicatorul luminos aferent butonului  și cel aferent butonului  vor clipi rapid simultan timp de 3 secunde, indicând revenirea la setările din fabrică. Debitul pentru fiecare funcție este readus la valoarea implicită, iar aparatul revine la starea normală de standby.

Atenționare:

1. Cafeaua poate fi preparată numai după finalizarea procesului de preîncălzire.
2. Dacă nu este acționat niciun buton în termen de 15 minute după ce indicatorul luminos aferent butonului de selectare a cantității de cafea se aprinde, aparatul va intra în standby, iar cele trei indicatoare se vor stinge.
3. În timpul preparării, procesul poate fi anulat prin apăsarea pe butonul de alimentare/start/stop. Dacă doriți să reporniți procesul de preparare, pur și simplu apăsați din nou pe butonul de alimentare/start/stop.
4. Apăsați pe butonul de comandă și butonul de selectare a cantității de cafea în funcție de preferințele dumneavoastră, iar indicatorul luminos corespunzător se va aprinde.
5. Apăsați pe butonul de alimentare/start/stop și, după un timp, cafeaua va începe să curgă din duză. După obținerea cantității de cafea dorite, curgerea se va opri automat, iar indicatorul luminos corespunzător va rămâne aprins.
6. După preparare, deschideți mânerul, scoateți cutia pentru capsule, deschideți capacul acesteia și scoateți capsula.

Avertisment:

- Nu deschideți mânerul în timpul procesului de preparare.
- Nu deschideți mânerul imediat după preparare, așteptați 5 secunde înainte de a-l deschide.
- Dacă doriți să preparați o altă ceașcă de cafea, utilizați o capsulă nouă.
- Goliți cutia pentru capsule și clătiți frecvent rezervorul și cutia pentru capsule în perioadele în care nu utilizați aparatul.

6. CURĂȚARE ȘI ÎNTREȚINERE

Înainte de efectuarea operațiilor de curățare, deconectați aparatul de la sursa de alimentare și lăsați-l să se răcească. Pentru evitarea incendiilor, a pericolului de electrocutare și a altor pericole la adresa siguranței personale, nu introduceți aparatul, cablul de alimentare sau ștecărul în apă sau în alte lichide. După fiecare utilizare, asigurați-vă că scoateți din priză ștecărul aparatului. Curățați aparatul cu regularitate după cum urmează:

1. Curățați rezervorul de apă detașabil cu o lavetă uscată.
2. Goliți și curățați cutia pentru capsule.
3. Curățați infuzorul pentru capsule cu o cârpă uscată.
4. Ștergeți cu o lavetă umedă suportul pentru ceașcă.
5. Pentru a curăța produsul, folosiți o lavetă umedă.
6. Montați toate componentele pentru următoarea utilizare.

Notă: Înainte de curățare, fierbeți mai întâi apa, curățați conducta din aparat și apoi opriți aparatul pentru ca acesta să se poată răci.

7. DEPANARE

Defecțiune	Soluție
Indicatoarele luminoase ale panoului de comandă nu se aprind.	Asigurați-vă că ștecărul este introdus corect în priză și că ați apăsat pe butonul de alimentare.
Aparatul produce zgomote ciudate.	Asigurați-vă că este suficientă apă în rezervor.
Indicatorul se aprinde, dar nu curge cafea.	Este posibil să fi fost utilizată o capsulă necorespunzătoare. Așteptați câteva secunde și încercați din nou cu o nouă capsulă.
Observați că a curs apă în partea inferioară a aparatului.	Asigurați-vă că rezervorul de apă este instalat corect.
Cutia pentru capsule nu poate fi introdusă în aparat.	Verificați dacă mânerul este deschis corect, acesta trebuie să fie deschis înainte de introducerea capsulei în cutia corespunzătoare.
Se aude un șuierat în timpul curgerii cafelei.	Aceasta nu este o defecțiune, ci sunetul normal produs de supapa de control al presiunii.

SERVICE ȘI ASISTENȚĂ PENTRU CLIEȚI

Utilizați numai piese de schimb originale.

Când contactați centrul nostru de service autorizat, asigurați-vă că aveți la îndemână următoarele informații: Denumirea modelului și numărul de serie.

Informațiile pot fi găsite pe plăcuța cu date tehnice. Acestea pot suferi modificări fără o notificare prealabilă.

DATE TEHNICE

Capacitatea rezervorului de apă	1,5 L
Putere	1215-1545 W

Vă mulțumim pentru achiziționarea acestui produs! Dacă aveți nevoie de asistență în ceea ce privește produsul dumneavoastră, vizitați site-ul nostru web utilizând linkurile de mai jos.

Obțineți manuale de utilizare: <https://www.heinner.ro>

Obțineți informații privind reparațiile: <https://www.heinner.ro>



Eliminarea deșeurilor în mod responsabil față de mediu

Va informam ca persoanele fizice au urmatoarele obligatii prin legislatia specifica privind protectia mediului si regimul deșeurilor:

- Deșeurile de echipamente electrice si electronice (DEEE), pot contine substante periculoase pentru mediu si sanatatea umana. Conform OUG 5/2015, exista obligativitatea predarii acestora, pentru tratarea corespunzatoare si valorificarea componentelor reciclabile. Societatea Network One Distribution S.R.L. este platitoare de taxa de "timbru verde" pentru fiecare Echipament Electric si Electronic (EEE) pe care il pune pe piata. Acest cost asigura tratarea ulterioara a echipamentelor uzate colectate. Din acest motiv, odata ce devine deșeu, produsul EEE poate fi predat gratuit operatorului Dvs. de salubritate, la magazine atunci cand achizitionati alt echipament similar, sistemul "unul la unu" sau la punctul de colectare organizat de Primaria Sectorului / localitatii Dvs.
- Simbolul (marcajul) aplicat produselor, care indica faptul ca deșeurile DEEE, bateriile si acumulatorii - fac obiectul unei colectari separate, il reprezinta o pubela barata cu o cruce.



Aceste masuri vor ajuta la protejarea mediului

Societatea Network One Distribution S.R.L. este inregistrata in Registrul de punere pe piata a echipamentelor electrice si electronice, avand numarul de inregistrare: RO-2016-03-EEE-0201-IV. De asemenea, au fost intocmite si sunt gestionate: Registrul de Retragere EEE si Registrul de Rechemare EEE, in conformitate cu HG 322/2013. Totodata societatea este inregistrata in Registrul de punere pe piata a bateriilor, avand numarul de inregistrare: RO-2011-03-B&A-0283.

Conformitatea cu directiva RoHS: Produsul pe care l-ați cumpărat este conform cu Directiva RoHS UE 2011/65/EU și 2015/863/EU. Nu conține materialele dăunătoare și interzise specificate în Directivă.

Va multumim ca participati alaturi de noi la protejarea mediului si a sanatatii umane!



HEINNER este marcă înregistrată a companiei **Network One Distribution SRL**. Celelalte branduri și denumirile produselor sunt mărci de comerț sau mărci de comerț înregistrate ale respectivilor deținători.

Nicio parte a specificațiilor nu poate fi reprodusă sub nicio formă și prin niciun mijloc, nici utilizată pentru obținerea unor derivate precum traduceri, transformări sau adaptări, fără consimțământul prealabil al companiei NETWORK ONE DISTRIBUTION.

Copyright © 2013 Network One Distribution. Toate drepturile rezervate.

www.heinner.com, <http://www.nod.ro>



Acest produs este proiectat și realizat în conformitate cu standardele și normele Comunității Europene.



Producător și importator: **Network One Distribution**

Str. Marcel Ianu, nr. 3-5, București, România

Tel: +40 21 211 18 56, www.heinner.com, www.nod.ro

office@nod.ro

ЕСПРЕСО МАШИНА С КАПСУЛИ

Модел: Café Supreme

HEMС-DD15BK



- Дигитален дисплей и сензорно управление
 - Капацитет на резервоара за вода: 1,5 л
- Съвместим с капсули Nespresso, Dolce Gusto и монодозы - монокапсули смелено кафе/ESE

HEINNER

1. ВЪВЕДЕНИЕ

Моля прочетете внимателно инструкциите и запазете наръчника за бъдещи справки.

Този наръчник има за цел да Ви предостави всички необходими инструкции по отношение на инсталирането, използването и поддържането на уреда. Преди инсталиране и използване на уреда, с цел правилна и безопасна употреба на уреда, моля прочетете внимателно този наръчник с инструкции.

2. СЪДЪРЖАНИЕ НА ВАШИЯ ПАКЕТ

- ➔ Еспресо машина с капсули
- ➔ Наръчник за употреба
- ➔ Сертификат за гаранция
- ➔ Декларация за съответствие

3. МЕРКИ ЗА БЕЗОПАСНОСТ

ОБЩИ ХАРАКТЕРИСТИКИ

1. Прочетете всички инструкции преди употреба.

2. Преди първата употреба уверете се, че захранващото напрежение, което е налично на мястото на употреба, съответства на стойностите, посочени върху табелката с техническите данни на уреда.

3. С цел предотвратяване на опасности, ако захранващият кабел е повреден, трябва да се подмени от производителя, от неговия сервизен представител или от лица с подобна квалификация.

4. Уредът може да се използва от деца на възраст най-малко 8 години и от лица с намалени физически, сетивни или умствени способности, или с липса на достатъчен опит и познания, само ако са под наблюдение или са получили указания във връзка с използването на уреда по безопасен начин и ако разбират опасностите, които могат да възникнат при използване на уреда. Децата нямат право да си играят с уреда. Почистването и поддръжката не трябва да се извършват от деца, освен ако са на възраст най-малко 8 години и са под наблюдение.

5. Не оставяйте уреда и захранващия кабел в близост до деца на възраст по-малка от 8 години тогава, когато уредът е включен или се охлажда.

6. За изключване от източника на захранване, завъртете контролните бутони в позиция „Изключено“ и извадете щепсела от контакта. Не дърпайте захранващия кабел, за да изключите щепсела.

7. Изключете уреда от източника на захранване, когато не се използва и преди извършване на операциите по почистване. Оставете уреда да изстива преди добавяне или премахване на аксесоари, както и преди неговото почистване.

8. Използването на аксесоари, които не се препоръчват от производителя, може да има като резултат възникване на пожар, токов удар или нараняване на хора.

9. Не използвайте уреда на открито.

10. Не използвайте уреда за цел, различна от тази, за която е проектиран.

11. Не оставяйте електрическия кабел да виси над ръба на масата или да контактува с горещи повърхности.

12. Не поставяйте уреда върху или до газова горелка или електрически котлон; не поставяйте уреда в нагрятата фурна.

13. Не оставяйте уреда да функционира без вода.

14. С цел защита от пожар, токов удар и нараняване не поставяйте захранващия кабел, щепсела или уреда във вода или други течности.

15. Съдът е предназначен за употреба с този уред. Той не трябва да се използва върху готварска печка.

16. Не почиствайте съда с прах за почистване, метални телчета или други абразивни материали.

17. Почистването и поддръжката може да извършват от деца, само ако са под наблюдение.

18. По време на функциониране на уреда определени негови части са горещи; не ги докосвайте с ръка. Използвайте само дръжките или бутоните.

19. Не потапяйте устройството в никаква течност.

20. Този уред е предназначен само за домашна употреба.

21. След употреба, повърхността на нагревателния елемент остава гореща.

22. Изключвайте уреда и изваждайте щепсела от контакта преди са сменят аксесоари или да се доближават до частите, които се движат по време на функциониране.
23. Съхранявайте този наръчник за бъдещи справки.



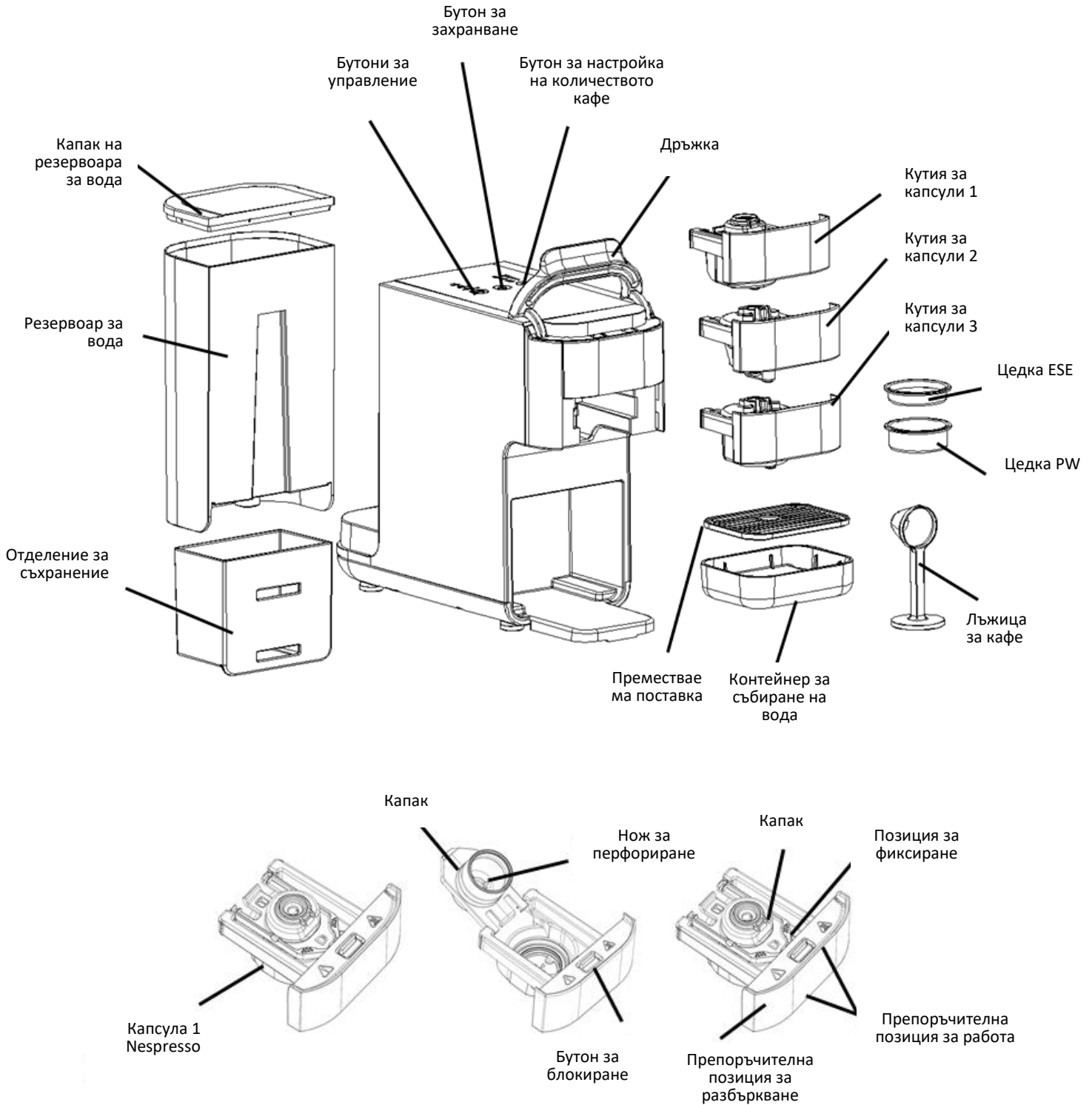

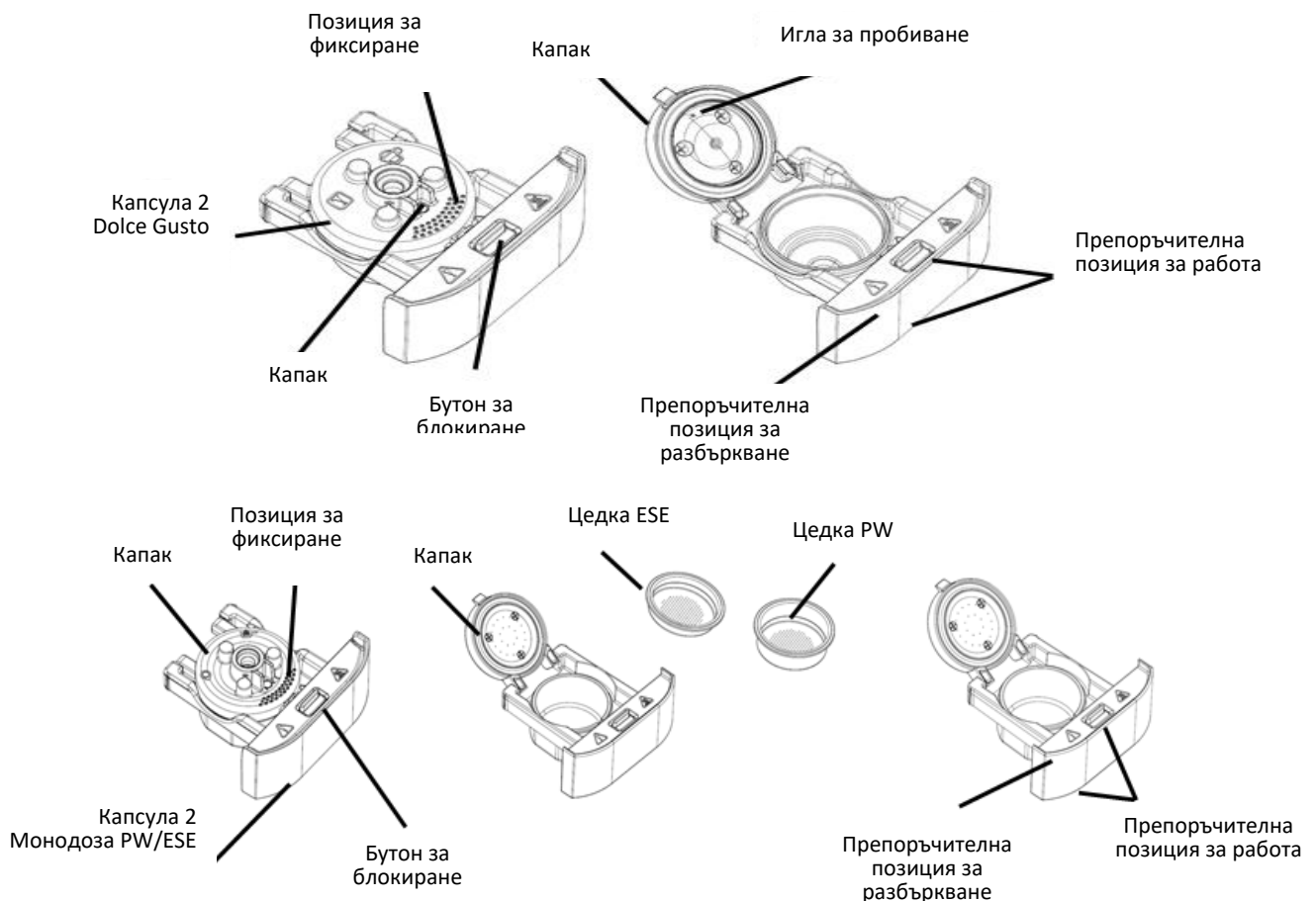







4. ОПИСАНИЕ НА ПРОДУКТА





5. ИЗПОЛЗВАНЕ НА УРЕДА

ОБЩИ ХАРАКТЕРИСТИКИ

Проверете дали аксесоарите са в добро състояние. Напълнете резервоара за вода, отворете ръкохватката, поставете кутията с капсули в машината, натиснете надолу ръкохватката и се уверете, че е затворена. Поставете съд върху поставката, свържете уреда към електрическата мрежа и натиснете бутона за включване/старт/спиране, за да започне уредът да се загрева. Бутонът за захранване/деблокиране  - индикаторът на този бутон започва да мига, докато светне ,  или  се включва. Това ще покаже, че уредът е завършил процеса на предварително загревяване. Можете да изберете една от желаните функции: ,  или . Натиснете бутона за избор на количество кафе, за да изберете , ,  или , след което натиснете бутона за захранване/старт/стоп . След кратко време от дюзата за кафе ще започне да тече вода. След като изтече определено количество вода, машината автоматично ще спре потока.

Обръщане на внимание: Когато се натисне бутонът за включване/старт/спиране , машината издава звук, който показва, че се изпомпва вода. Това означава, че машината изпомпва вода за приготвяне на кафе, което е нормално в този случай.

Забележка: Когато ръкохватката е отворена, всеки индикатор на панела мига и бутоните за управление не могат да се задействат в този момент.



Предупреждение: Тази машина е подходяща само за капсули Nespresso, капсули Dolce Gusto, моно-капсули ESE, капсули за мляно кафе.

Предупреждение: Не отваряйте ръкохватката по време на процеса на приготвяне на кафе, тъй като това може да повлияе на водния поток.





НАЧИН НА УПОТРЕБА

Приготвяне на кафето:



1. След приключване на процеса на предварително загряване натиснете бутона за управление, за да активирате желаната функция, както следва:

- **един път** за Nespresso 
- **два пъти** за Dolce Gusto 
- **три пъти** за смляно кафе/ESE 

2. Натиснете отново бутона за избор на количество кафе и изберете едно от наличните количества

кафе, които могат да бъдат приготвени: единично , двойно  или дълго кафе . След това натиснете бутона за включване/стартране/спиране , за да започнете приготвянето на кафето.

Забележка: когато използвате капсули Dolce Gusto, светлинният индикатор на чашата автоматично ще се превключи към зоната с нива от 1 до 7. След това натиснете бутона за избор на количество кафе и



ще бъдете помолени да изберете между нива от 1 до 7, представени от зоната на нивото . Ниво 1 е най-ниското, а ниво 7 е най-високото. Ниво 3 е стандартното ниво. След избора натиснете бутона за включване/стартране/спиране  отново, и машината автоматично ще започне съответната функция за приготвяне на кафе.



Избор на чашка:

Функция/размер на чашката	Обикновено	Двойно	Дълго
Nespresso	30 ml	60 ml	110 ml
Мондоза смляно кафе/ESE	30 ml	60 ml	110 ml

Функция/размер на чашката	1	2	3	4	5	6	7
Dolce Gusto	30 ml	40 ml	70 ml	110 ml	160 ml	170 ml	220 ml

Функция за регулиране на дебита:

Когато е избрана една от функциите на Nespresso, капсула за мляно кафе/ESE/SES, и машината е в режим на готовност, можете да започнете да настройвате, докато свети индикаторът за желания дебит (нормално кафе , двойно , дълго ).

Например, когато индикаторът за обикновената чаша за кафе  свети, натиснете и задръжте бутона, за да изберете количеството кафе  за 2 секунди, за да включите кафемашината, и индикаторът на бутона за избор на количество кафе ще  започне да мига. Изчакайте, докато потече желаното количество кафе, след което натиснете отново бутона за избор на количество кафе. Потокът на кафе ще спре и машината автоматично ще запази настройката и ще влезе в режим на готовност.



Предупреждение:

1. Функцията за регулиране на дебита ще бъде деактивирана, дори ако машината се стартира отново след изключване.
2. Ако зададеният дебит надхвърли регулируемия диапазон, уредът автоматично ще запише максималната стойност.

3. Ако зададеният дебит е под регулируемия диапазон, уредът автоматично ще запише минималната стойност.

4. Настройката на дебита е възможна само за функциите Nespresso и мляно кафе/ESE капсули; функцията Dolce Gusto не позволява персонализиране на настройката на дебита.



Напомняне за предупреждение за разхода:

По време на приготвяне на кафе, когато бутонът за управление  и бутонът за избор на количество кафе  мигат едновременно, помпата спира да работи:



1. Ако дюзата не работи, проверете дали в резервоара има достатъчно вода. Ако няма, добавете вода в резервоара (може да се наложи да изчакате 2 минути, преди да продължите приготвянето на кафе).
2. Ако кафето тече твърде бавно, кутията за капсули може да е блокирана - проверете кутията за капсули и я почистете.
3. Ако кафето тече твърде бавно, проверете дали използвате правилната марка капсули. Капсулите на други марки може да не съответстват по размер, което може да доведе до неправилно функциониране на машината.



Напомняне за отстраняване на отлагания от варовик (котлен камък):

След повече от 500 цикъла на приготвяне на кафе машината автоматично ще покаже напомняне за необходимостта от отстраняване на варовиковите отлагания. Предупреждението ще изчезне само след използване на функцията за отстраняване на варовик. Докато функцията за предупреждение е активна, машината може да работи нормално (актуалният брой цикли няма да се нулира след възстановяване на фабричните настройки).



Когато функцията за предупреждение е активна, индикаторът на бутона  и индикаторът на бутона за избор на количество кафе  мигат последователно.

Процедура за отстраняване на отлагания от варовик:

Когато машината влезе в режим на готовност, натиснете и задръжте бутона  и бутона за избор на количеството кафе  за 5 секунди, за да активирате функцията за отстраняване на котлен камък.

В този момент индикаторът на бутона  и сензорът на бутона  ще мигат бързо едновременно. След като добавите подходящо количество препарат за отстраняване на котлен камък в резервоара за вода, натиснете бутона за включване (бутон за стартиране/спиране) , и машината ще започне процеса (процесът отнема около 2 минути).

Деактивиране на функцията за отстраняване на отлагания от варовик:

Когато функцията за отстраняване на котлен камък е активна, натиснете и задръжте едновременно за 5 секунди бутона  и бутона за избор на количеството кафе . Уредът автоматично ще деактивира функцията за отстраняване на котлен камък и ще се върне към нормална работа; или просто изключете уреда и го стартирайте отново, за да деактивирате функцията за отстраняване на котлен камък.





Активиране на режим на готовност след 15 минути:

При нормални условия на работа, след включване и предварително загряване, уредът преминава в режим на готовност. Ако в продължение на 15 минути не е избрана никаква функция, уредът ще премине в режим на готовност ("standby").

По същия начин, ако функцията за предупреждение за изтичане е активна и не е натиснат бутон в продължение на 4 минути, уредът преминава в състояние на покой.

След натискане на който и да е бутон или отваряне на ръкохватката, уредът ще излезе от състоянието на покой и ще рестартира процеса на предварително нагриване.

Връщане към фабрични настройки:

Когато устройството е свързано към захранването, но е в режим на готовност, натиснете и задръжте едновременно бутона  и бутона за избор на количество кафе  за 5 секунди, а машината ще издаде дълъг звуков сигнал. След като направите това, светлинният индикатор на бутона  и този на бутона  ще мига бързо едновременно в продължение на 3 секунди, което означава връщане към фабричните настройки. Дебитът за всяка функция се нулира до стойността по подразбиране и устройството се връща в нормален режим на готовност.

Обръщане на внимание:

1. Кафето може да се приготвя само след приключване на процеса на предварително затопляне.
2. Ако в рамките на 15 минути не бъде натиснат нито един бутон, след като светне индикаторът до бутона за избор на количество кафе, машината ще премине в режим на готовност и трите индикатора ще угаснат.
3. По време на приготвянето на кафето, процесът може да бъде отменен чрез натискане на бутона за захранване/стартиране/спиране. Ако желаете да рестартирате процеса на варене, просто натиснете отново бутона за захранване/стартиране/спиране.
4. Натиснете бутона за управление и бутона, за да изберете количеството кафе според предпочитанията си, и съответният светлинен индикатор ще светне.
5. Натиснете бутона за захранване/стартиране/спиране и след известно време кафето ще започне да тече от дюзата. След като желаното количество кафе бъде приготвено, потокът ще спре автоматично и съответната индикаторна лампичка ще остане да свети.
6. След приготвянето на кафето отворете ръкохватката, извадете кутията за капсули, отворете капака и извадете капсулата.

Предупреждение:

- Не отваряйте ръкохватката по време на процеса на варене.
- Не отваряйте ръкохватката веднага след приготвянето на кафето, изчакайте 5 секунди, преди да отворите.
- Ако искате да пригответе още една чаша кафе, използвайте нова капсула.
- Изпразвайте кутията за капсули и изплаквайте често резервоара и кутията за капсули, когато не ги използвате.

6. ПОЧИСТВАНЕ И ПОДДРЪЖКА

Преди да извършите операциите по почистване, изключете уреда от електрическата мрежа и го оставете да изстине. За да избегнете пожар, токов удар и други опасности за личната безопасност, не потапяйте уреда, захранващия кабел или капака за пръски във вода или други течности. След всяка употреба не забравяйте да изключвате уреда от електрическата мрежа. Почиствайте редовно уреда, както следва:

1. Почистете подвижния резервоар за вода със суха кърпа.
2. Изпразнете и почистете кутията за капсули.
3. Почистете инфузора за капсули със суха кърпа.
4. Избършете поставката за чаши с влажна кърпа.
5. Използвайте влажна кърпа, за да почистите продукта.
6. Сглобете всички компоненти за следваща употреба.

Забележка: Преди да почистите, първо кипнете водата, почистете тръбата в уреда и след това изключете уреда, за да може да изстине.

7. ОТСТРАНЯВАНЕ НА НЕИЗПРАВНОСТИ

Неизправност	Решение
Индикаторите на контролния панел не светят.	Уверете се, че щепселът е включен правилно и че е натиснат бутонът за включване на захранването.
Уредът издава странни звуци.	Уверете се, че в резервоара има достатъчно вода.
Индикаторът светва, но не тече кафе.	Възможно е да е използвана неправилна капсула. Изчакайте няколко секунди и опитайте отново с нова капсула.
Забелязвате, че е текла вода в долната част на машината.	Уверете се, че резервоарът за вода е поставен правилно.
Кутията за капсули не може да бъде поставена в уреда.	Проверете дали ръкохватката е отворена правилно, тя трябва да е отворена, преди да поставите капсулата в кутията за капсули.
Чува се съскащ шум, докато тече кафето.	Това не е повреда, а нормален звук, произвеждан от клапана за регулиране на налягането.

СЕРВИЗ И ОБСЛУЖВАНЕ НА КЛИЕНТИ

Използвайте само оригинални резервни части.

Когато се свързвате с нашия оторизиран сервизен център, уверете се, че имате под ръка следната информация: Наименование на модела и сериен номер.

Информацията може да бъде намерена на табелката с технически данни. Те подлежат на промяна без предварително уведомление.

ТЕХНИЧЕСКИ ДАННИ

Обем на контейнера за вода	1,5 Л
Мощност	1215-1545W

Благодарим Ви за закупуването на този продукт! Ако се нуждаете от помощ за вашия продукт, посетете нашия уебсайт, като използвате линковете по-долу.

Получете ръководства за употреба: <https://www.heinner.ro>

Получете информация за ремонт: <https://www.heinner.ro>

**Изхвърляне на отпадъците по начин, отговорен за околната среда**

Можете да помогнете за опазването на околната среда!

Моля спазвайте местните разпоредби: Предайте нефункциониращото електрическо оборудване на център за събиране на отпадъци от електрическо оборудване.



HEINNER е регистрирана марка на компанията **Network One Distribution SRL**. Останалите търговски марки и наименованията на продуктите са търговски марки или регистрирани търговски марки на съответните им притежатели.

Нито една част от спецификациите не може да бъде възпроизвеждана под каквато и да е форма или средство, или използвана за получаване на производни като преводи, трансформации или адаптации, без предварителното съгласие на компанията NETWORK ONE DISTRIBUTION.

Copyright © 2013 Network One Distribution. Всички права запазени.

www.heinner.com, <http://www.nod.ro>



Този продукт е проектиран и произведен в съответствие със стандартите и нормите на Европейската общност.



Производител и вносител : **Network One Distribution**

ул. Марчел Янку № 3-5, Букурещ, Румъния

Тел: +40 21 211 18 56, www.heinner.com , www.nod.ro

office@nod.ro

KAPSZULÁS KÁVÉFŐZŐ

Modell: Café Supreme

HEMC-DD15BK



- Digitális panel és érintésvezérlés
 - Víztartály kapacitása: 1,5 L
- Kompatibilis Nespresso, Dolce Gusto kapszulákkal és őrölt kávéval tartalmazó ESE párnákkal

HEINER

1. BEVEZETŐ

Kérjük, figyelmesen olvassa el az utasításokat, és őrizze meg a kézikönyvet későbbi tanulmányozás céljából. A kézikönyv célja a készülék beszerelésével, használatával és karbantartásával kapcsolatos minden szükséges tudnivalót rendelkezésére bocsátani. A készülék helyes és biztonságos használata érdekében, kérjük, hogy beszerelés és használat előtt olvassa el figyelmesen a használati kézikönyvet.

2. AZ ÖN CSOMAGJÁNAK TARTALMA

- ➔ **Kapszulás kávéfőző**
- ➔ **Használati kézikönyv**
- ➔ **Jótállási bizonylat**
- ➔ **Megfelelőségi nyilatkozat**

3. BIZTONSÁGI INTÉZKEDÉSEK

ÁLTALÁNOSÁGOK

1. Használat előtt olvasson el minden utasítást.

2. A készülék használata előtt, kérjük, bizonyosodjon meg afelől, hogy a használat tervezett helyszínén a villamos hálózatban lévő áram feszültsége egyezik a termék számára előírt feszültséggel.
3. A balesetek elkerülése érdekében a sérült tápvezetékét a gyártóval, a gyártó szerviz ügynökével vagy hasonló képzettséggel rendelkező személlyel cseréltesse ki.
4. A készüléket 8 év fölötti gyermekek, csökkent fizikai, érzéki vagy szellemi képességekkel, gyakorlattal vagy ismeretekkel rendelkezők csak akkor használhatják, ha felügyelik, vagy felkészítik őket a készülék biztonságos használatára, és ha megértik a készülék használatával járó veszélyeket. Tilos gyermekeknek a készülékkel játszani. A készülék tisztítását és karbantartását nem végezhetik gyermekek, kivéve, ha legalább 8 évesek, és felügyelve vannak.
5. Ne hagyja a készüléket és a tápvezetékét 8 éven aluli gyermekek keze ügyében.
6. A készülék kikapcsolásához fordítsa a kapcsológombot a „Kikapcsolva” helyzetbe, és húzza ki a dugaszt a csatlakozóaljzatból. Az áramellátás megszakítására ne húzza ki a tápkábeltől fogva a dugaszt az áramforrásból.
7. A készüléket áramtalanítsa, ha éppen használaton kívül van vagy tisztítás előtt. A tartozékok hozzacsatolása vagy eltávolítása, valamint a készülék tisztításának megkezdése előtt hagyja a készüléket kihűlni.
8. A gyártó által nem ajánlott kiegészítők használata tüzesethez, áramütéshez vagy személyi sérülésekhez vezethet.
9. Ne használja a készüléket a szabadban.
10. Ne használja a berendezést a rendeltetésétől eltérő célokra.
11. Ne engedje az elektromos vezetékét, hogy lelógjon az asztalról vagy a konyhalapról, illetve vigyázzon, nehogy valami forró felülethez érjen.
12. Ne helyezze a készüléket gázégőre vagy elektromos főzőkészülékre, sem ezek mellé; ne helyezze a készüléket befűtött sütőbe.
13. Ne hagyja a készüléket víz nélkül működni.
14. A tüzesetek, áramütések és személyi sérülések elkerülése céljából ne helyezze, vagy ne merítse a berendezést, annak tápkábelét vagy annak dugaszát vízbe vagy egyéb folyadékba.
15. Az edényt ehhez a készülékhez gyártották, ne használja tűzhelyen.
16. Ne tisztítsa az edényt tisztítószerrel, fémszivaccsal vagy más dörzshatású anyagokkal.
17. Vigyázzon, hogy a főzési ciklusok során ne forrázzák meg a forró gőzök.
18. A berendezés működése közben annak bizonyos részei felforrósodhatnak, kerüljék az azok közvetlen érintését. Kizárólag csak a fogantyúkat és a gombokat használja.
19. Ne merítse a készüléket semmilyen folyadékba.
20. Ezt a készüléket csak háztartási használatra tervezték.

21. Használat után, a melegítő elem felülete forró marad.

22. A tartozékok cseréje és a mozgó részek érintése előtt állítsa meg a gépet és húzza ki a kábelt a konnektorból.

23. Őrizze meg ezt a használati útmutatót a jövőbeni használatra.



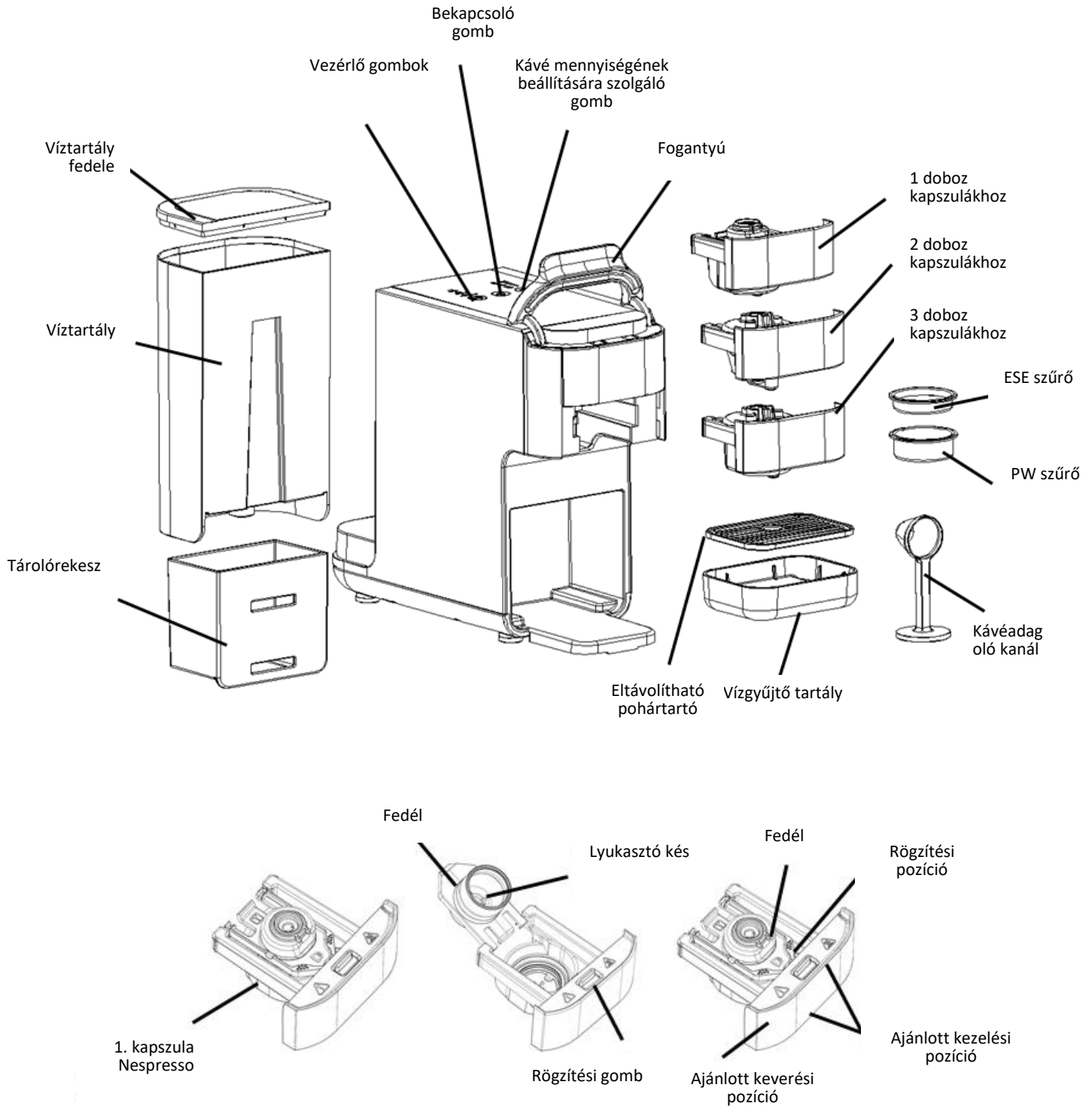

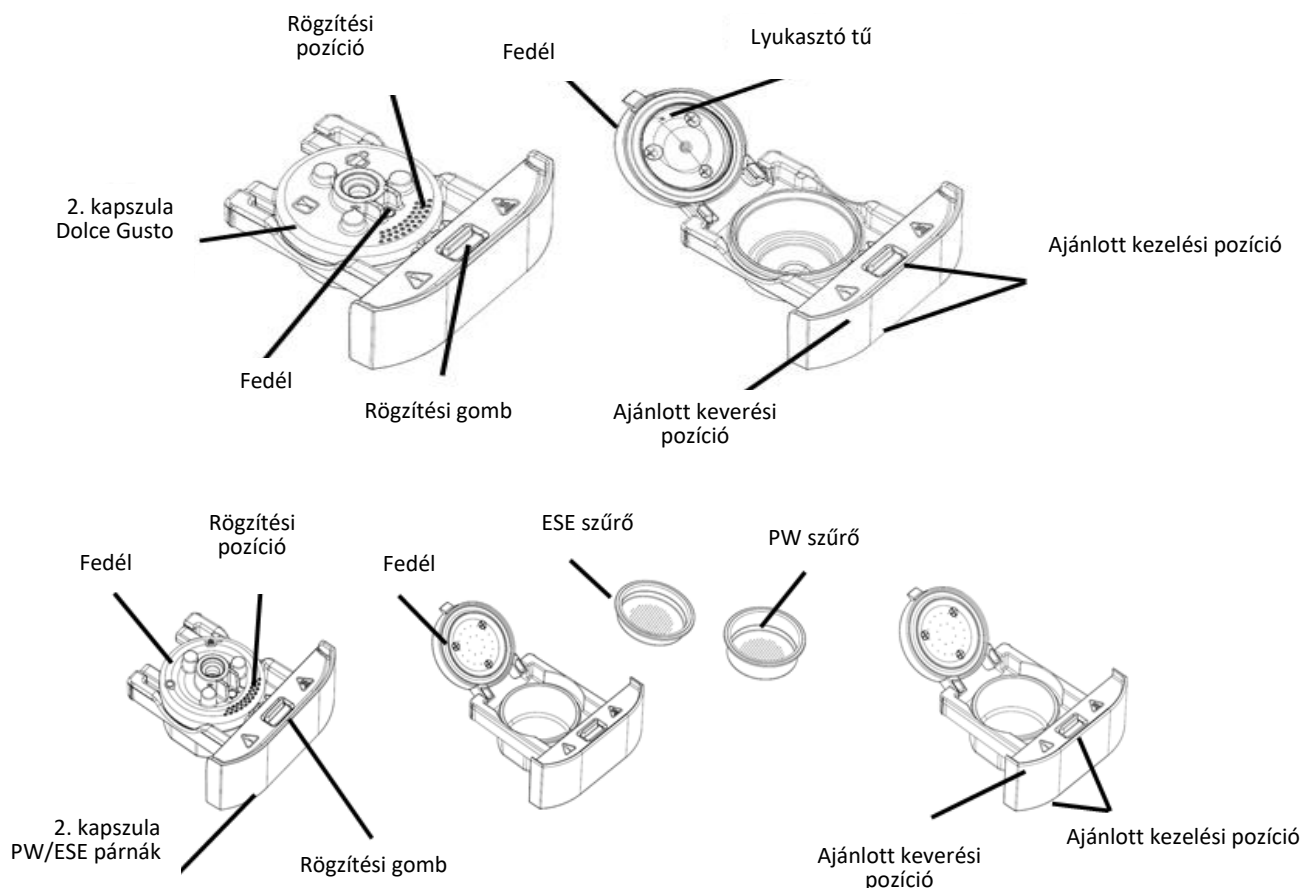



4. A TERMÉK LEÍRÁSA





5. A KÉSZÜLÉK HASZNÁLATA

ÁLTALÁNOSÁGOK

Ellenőrizze a tartozékokat és győződjön meg róla, hogy minden tartozék sértetlen. Töltse fel a víztartályt, majd nyissa ki a fogantyút, helyezze be a kapszulatartót a készülékbe, majd nyomja le a fogantyút, és zárja be. Helyezzen egy edényt a tartóra, majd csatlakoztassa a készüléket az áramforráshoz, és nyomja meg a bekapcsolás/start/stop gombot, így a készülék elkezd melegedni. Bekapcsolás/feloldás - ehhez tartozó jelzőfény világítani kezd, amíg fel nem gyullad a  vagy  jelzőfénye. Ez azt jelzi, hogy a készülék befejezte az előmelegítési folyamatot. Kiválaszthatja a kívánt funkciók egyikét:  vagy . Nyomja meg a kávémenyiség-választó gombot a ,  vagy  kiválasztásához, majd nyomja meg a bekapcsoló/indító/leállító  gombot. Rövid idő múlva a kávéfűvókából elkezd folyni a víz. Egy bizonyos vízmennyiség kifolyása után a gép automatikusan leállítja a vízfolyást.

Figyelmeztetés: Bekapcsolás/start/stop gomb  megnyomásakor a készülék hangot ad ki, jelezve a víz pumpálását. Ez normális működés, és azt jelenti, hogy a készülék vizet pumpál a kávékészítéshez.

Megjegyzés: Ha a fogantyú nyitva van, a vezérlőpanel összes jelzőfénye villog, és a vezérlőgombok nem használhatók.

Figyelmeztetés: Ez a készülék kizárólag Nespresso kapszulákhoz, Dolce Gusto kapszulákhoz, ESE párnákhoz és őrölt kávéval tartalmozó kapszulákhoz alkalmas.

Figyelmeztetés: Ne nyissa fel a fogantyút a kávékészítés folyamata közben, hogy ne zavarja a víz folyását.

HASZNÁLATI MÓD

Kávé készítése:





1. Az előmelegítési folyamat befejezése után nyomja meg a vezérlőgombot a kívánt funkció aktiválásához az alábbiak szerint:

- **egyszer nyomva:** Nespresso 



- **kétszer nyomva:** Gusto 

- **háromszor nyomva:** őrölt kávé tartalmazó/ESE párna 

2. . Nyomja meg ismét a kávémennyiség kiválasztó gombot, és válassza ki az elérhető kávémennyiségek

egyikét: szimpla , dupla  vagy hosszú  . Ezután nyomja meg a bekapcsolás/start/leállítás  gombot, hogy elindítsa a kávékészítést.

Megjegyzés: Ha Dolce Gusto kapszulákat használ, a csészéhez tartozó jelzőfény automatikusan átvált az 1-től 7-ig terjedő szintzónára. Ezután nyomja meg a kávémennyiség kiválasztó gombot, és válasszon az 1 és 7



közötti szintek közül, amelyeket a szintzóna  jelez. 1-es szint a legalacsonyabb, valamint a 7-es szint a legmagasabb. A 3-as szint a standard beállítás. A kiválasztás után nyomja meg a bekapcsolás/start/leállítás  gombot, és a készülék automatikusan elindítja a megfelelő kávékészítési funkciót.



Csésze kiválasztása :

Funkció/ csészeméret	Szimpla	Dupla	Hosszú
Nespresso	30 ml	60 ml	110 ml
Őrölt kávé tartalmazó/ESE párna	30 ml	60 ml	110 ml

Funkció/ csészeméret	1	2	3	4	5	6	7
Dolce Gusto	30 ml	40 ml	70 ml	110 ml	160 ml	170 ml	220 ml

Áramlásszabályozó funkció:

Ha az Nespresso, őrölt kávékapszula/ESE/SES funkciók egyikét választja, és a készülék készenléti módban van, megkezdheti a beállítást, amíg a kívánt áramlásnak megfelelő jelzőfény (szimpla , dupla , hosszú ) világít.



Például, ha a szimpla kávécsésze  jelzőfénye világít, tartsa lenyomva a kávémennyiség  kiválasztó gombot 2 másodpercig, hogy elindítsa a kávéfőzést. A kávémennyiség kiválasztó gombhoz tartozó jelzőfény  villogni kezd. Várja meg, amíg a kívánt mennyiségű kávé kifolyik, majd nyomja meg ismét a kávémennyiség kiválasztó gombot. A kávé kifolyása leáll, a készülék automatikusan elmenti a beállítást, és visszatér készenléti módba.

Figyelmeztetés:

1. Az áramlásszabályozó funkció letiltásra kerül, még akkor is, ha a készüléket újraindítják kikapcsolás után.
2. Ha a beállított áramlás meghaladja a szabályozható tartományt, a készülék automatikusan a maximális értéket menti el.
3. Ha a beállított áramlás a szabályozható tartomány alatt van, a készülék automatikusan a minimális értéket menti el.

4. Az áramlásszabályozás csak az Nespresso és az őrölt kávé/ESE kapszula funkciókhoz állítható be; a Dolce Gusto funkció nem támogatja az áramlás egyedi szabályozását.



Áramlásfigyelmeztetés emlékeztető:

Kávékészítés közben, ha a vezérlőgomb  és a kávémenyiség kiválasztó gomb  egyszerre villognak, a szivattyú leállt:



1. Ha a fúvóka nem működik, ellenőrizze, hogy van-e elegendő víz a tartályban. Ha nincs, töltsön vizet a tartályba (előfordulhat, hogy 2 percet várnia kell, mielőtt folytathatja a kávékészítést).
2. Ha a kávé túl lassan folyik, akkor lehetséges, hogy a kapszulatartó el van akadva – ellenőrizze és tisztítsa meg a kapszulatartót.
3. Ha a kávé túl lassan folyik, akkor ellenőrizze, hogy megfelelő márkájú kapszulát használ-e. Más márkák kapszulái eltérhetnek méretben, ami a készülék hibás működését okozhatja.



Vízkömentesítés emlékeztető:

Több mint 500 kávékészítési ciklus után a készülék automatikusan figyelmeztetést jelenít meg a vízkömentesítés szükségességéről. Ez a figyelmeztetés csak a vízkömentesítő funkció használata után tűnik el. Amíg a figyelmeztetés aktív, a készülék normálisan működhet (a ciklusok száma nem áll vissza a gyári beállítások visszaállítása után sem).



Ha a figyelmeztetés aktív, a vezérlőgombhoz  tartozó jelzőfény és a kávémenyiség kiválasztó  gomb jelzőfénye felváltva villog.

Vízkömentesítési eljárás:

Amikor a készülék készenléti állapotba lép, tartsa lenyomva egyszerre 5 másodpercig a vezérlőgombot  és a kávémenyiség kiválasztó  gombot, hogy aktiválja a vízkömentesítő funkciót.

Ekkor a vezérlőgomb  és a kávémenyiség kiválasztó  gomb jelzőfényei egy időben villogni kezdenek. Miután megfelelő mennyiségű vízkőoldót adott a víztartályba, nyomja meg a bekapcsoló gombot (start/stop gomb) , és a készülék elindítja a folyamatot (a folyamat körülbelül 2 percig tart).

A vízkömentesítő funkció kikapcsolása:

Amikor a vízkömentesítő funkció aktív, tartsa lenyomva egyszerre 5 másodpercig a vezérlőgombot  és a kávémenyiség kiválasztó  gombot. A készülék automatikusan kikapcsolja a vízkömentesítő funkciót, és visszatér a normál működési állapotba; vagy egyszerűen kapcsolja ki a készüléket, majd indítsa újra a vízkömentesítő funkció kikapcsolásához.





Az alvó üzemmód aktiválása 15 perc után:

Normál működési körülmények között, a bekapcsolás és az előmelegítés után a készülék készenléti állapotba lép. Ha 15 percig nem választ ki semmilyen funkciót, a készülék automatikusan átvált alvó üzemmódba.

Amennyiben az áramlásfigyelmeztető funkció aktív, és 4 percig nem nyom meg egyetlen gombot sem, a készülék szintén alvó üzemmódba lép.

Ha bármelyik gombot megnyomja, vagy kinyitja a fogantyút, a készülék kilép az alvó üzemmódból, és újraindítja az előmelegítési folyamatot.

Gyári beállítások visszaállítása:

Csatlakoztassa a készüléket az áramforráshoz, és győződjön meg róla, hogy készenléti állapotban van. Tartsa lenyomva egyszerre a vezérlőgombot  és a kávémenyiség kiválasztó  gombot 5 másodpercig. A készülék egy hosszú hangjelzést ad. Ezt követően a vezérlőgombhoz  és a kávémenyiség kiválasztó  gombhoz tartozó jelzőfények gyorsan villognak 3 másodpercig, jelezve, hogy a gyári beállítások visszaálltak. Minden funkció áramlási értéke visszaáll az alapértelmezett beállításokra, és a készülék normál készenléti állapotba kerül.

Figyelmeztetés:

1. A kávé csak az előmelegítési folyamat befejezése után készíthető el.
2. Ha a kávémenyiség kiválasztó gombhoz tartozó jelzőfény felgyulladás után 15 percen belül nem nyomnak meg egyetlen gombot sem, a készülék készenléti állapotba lép, és mindhárom jelzőfény kialszik.
3. Kávékészítés közben a folyamat megszakítható a bekapcsolás/start/leállítás gomb megnyomásával. Ha újra szeretné indítani a folyamatot, nyomja meg ismét a bekapcsolás/start/ leállítás gombot.
4. Nyomja meg a vezérlőgomb és a kávémenyiség kiválasztó gombokat az Ön preferenciái szerint, és a megfelelő jelzőfény világítani fog.
5. Nyomja meg a bekapcsolás/start/leállítás gombot, és rövid idő múlva a kávé elkezdi folyni a kávéfűvókából. A kívánt kávémenyiség elérése után a folyamat automatikusan leáll, és a megfelelő jelzőfény világítva marad.
6. A kávékészítés után nyissa fel a fogantyút, vegye ki a kapszulatartót, nyissa fel annak fedelét, és távolítsa el a használt kapszulát.

Figyelmeztetés:

- Ne nyissa fel a fogantyút a kávékészítés folyamata közben.
- Ne nyissa fel a fogantyút közvetlenül a kávékészítés után, várjon legalább 5 másodpercet, mielőtt kinyitná.
- Ha egy újabb csésze kávé szeretne készíteni, mindig használjon új kapszulát.
- A kapszulatartót rendszeresen ürítse ki, és a víztartályt, valamint a kapszulatartót gyakran öblítse ki a készülék használatának szüneteltetése során.

6. TISZTÍTÁS ÉS KARBANTARTÁS

Mielőtt tisztítaná a készüléket, húzza ki a hálózati áramforrásból, és hagyja lehűlni. Tűzveszély, áramütés és egyéb biztonsági kockázatok elkerülése érdekében ne merítse a készüléket, a tápkábelt vagy a dugót vízbe vagy más folyadékba. Minden használat után győződjön meg róla, hogy kihúzza a készüléket a hálózati aljzatból. Tisztítsa rendszeresen a készüléket az alábbiak szerint:

1. A levehető víztartályt tisztítsa meg egy száraz kendővel.
2. Ürítse ki és tisztítsa meg a kapszulatartót.
3. A kapszula infúziós egységét törölje át egy száraz kendővel.
4. A csészétartót törölje le egy nedves kendővel.
5. A termék tisztításához használjon nedves ruhát.
6. Szerelje össze az összes alkatrészt a következő használatához.

Megjegyzés: A tisztítás előtt forraljon fel vizet, tisztítsa meg a készülék vezetőkeit, majd kapcsolja ki a készüléket, hogy lehülhessen.

7. HIBAELHÁRÍTÁS

Hiba	Megoldás
A vezérlőpanel jelzőfényei nem világítanak.	Győződjön meg arról, hogy a dugó megfelelően csatlakozik az aljzathoz, valamint ellenőrizze, hogy megnyomta-e a bekapcsoló gombot.
A készülék furcsa zajokat ad ki.	Ellenőrizze, hogy van-e elegendő víz a tartályban.
A jelzőfény világít, de nem folyik kávé.	Lehetséges, hogy nem megfelelő kapszulát használt. Várjon néhány másodpercet, majd próbálja meg újra egy új kapszulával.
Víz szivárog a készülék alsó részén.	Ellenőrizze, hogy a víztartály megfelelően van-e beszerelve.
A kapszulatartó nem helyezhető be a készülékbe.	Ellenőrizze, hogy a fogantyú megfelelően ki van-e nyitva. A fogantyút ki kell nyitni, mielőtt a kapszulát a megfelelő tartóba helyezné.
A kávé főzése közben sziszegő hang hallatszik.	Ez nem meghibásodás, hanem a nyomásszabályozó szelep által kibocsátott normális hang.

SZERVIZ ÉS ÜGYFÉLSZOLGÁLAT

Csak eredeti cserealkatrészeket használjon.

Mielőtt felvenné a kapcsolatot az engedélyezett szakszervizünkkel, győződjön meg róla, hogy a következő adatok a rendelkezésére állnak: Modell megnevezése és sorozatszám.

Ezeket az adatokat a készülék műszaki adattábláján találja. Ezek az adatok előzetes értesítés nélkül is megváltoztathatók.

MŰSZAKI ADATOK

Víztartály kapacitása	1,5 L
Teljesítmény	1215-1545W

Köszönjük, hogy megvásárolta termékünket! Ha segítségre van szüksége a termékkel kapcsolatban, kérjük, látogasson el weboldalunkra az alábbi linkek segítségével.

Használati útmutatók beszerzése: <https://www.heinner.ro>

Javítási információk letöltése: <https://www.heinner.ro>



A hulladékok környezetfelelős eltávolítása

Segíthet a környezet védelmében!

Kérjük, tartsa be a helyi rendelkezéseket: a nem működő elektromos berendezéseket a használt elektromos hulladékokat gyűjtő központba szolgáltatassa be.



A **HEINNER** a **Network One Distribution SRL(KFT)** társaság által bejegyzett védjegy. A többi márkajelzés és a termékek megnevezése kereskedelmi vagy az illető birtoklók által bejegyzett márkanevek.

A leírtak egyetlen része sem használható fel semmilyen formában, még lefordított, átalakított változatban sem, a NETWORK ONE DISTRIBUTION előzetes beleegyezése nélkül.

Copyright © 2013 Network One Distribution. Minden jog fenntartva.

www.heinner.com, <http://www.nod.ro>



A terméket az Európai Közösség előírásainak és jogszabályainak megfelelően tervezték és gyártották.



Gyártó és importőr: **Network One Distribution**

Marcel Iancu utca, 3-5 szám, Bukarest (București), Románia

Tel: +40 21 211 18 56, www.heinner.com , www.nod.ro

office@nod.ro